

SONY®

A Bigger,
Brighter Future.

VPL-FX52/L
3-LCD Installation Projectors

www.sonybiz.net/projectors



SONY®



A High-Performance Installation Projector with Astonishing Brightness



**THE MAGIC OF SONY
3LCD TECHNOLOGY**

BRIGHTER PICTURE

HIGHER DETAIL

NATURAL COLOUR



You need light, power, flexibility and great performance, but you also demand a projector that's easy to set up and a dream to use. Sony's stylish and flexible VPL-FX52/L installation projector is perfect for showcasing presentations, multimedia, video and images wherever you need a bigger, better-quality picture and maximum impact.

Delivering stunning brightness of 6000 ANSI lumens, superb colour reproduction and crisp, clear, high-impact images, the VPL-FX52/L is the ideal solution for mid to large-size venues such as auditoriums, museums, conference rooms, training rooms and large classrooms.

This beautifully-designed projector is packed with features that are easy to access and simple to use – meaning that you really can get the most out of your investment as well as your presentations. The VPL-FX52/L works with a wide variety of signals, right up to HDTV, so media from a range of sources can be played.



POWER ZOOM / FOCUS / PICTURE SHIFT

The Zoom, Focus, and Picture Shift functions of the supplied power-operated lens* can be controlled both from the projector control panel and the supplied remote control unit. Images can be quickly and easily adjusted to the desired settings.

* Available only on the lens supplied with the VPL-FX52.

BACK-TO-FRONT TILT AND TWIN STACKING CAPABILITY

The VPL-FX52/L can be tilted up to 90° upwards or downwards, giving even more installation options.

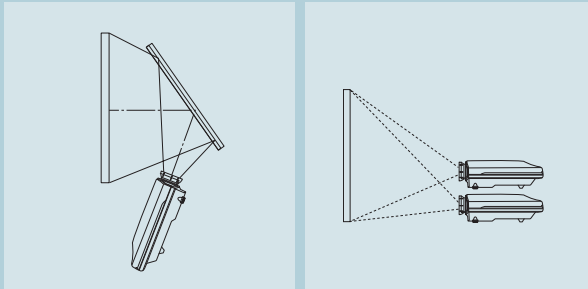

Back-to-Front Tilt Capability

Twin Stacking Capability

When applications require double the light output, the VPL-FX52/L can be twin-stacked to produce an amazing 12,000 ANSI lumens. Pictures from the two projectors are then matched using the Picture Shift function on each unit.

The optional VPLL-FM21 projection lens cannot be used when the VPL-FX52 or VPL-FX52L are stacked.

WIDE RANGE OF INPUTS

The VPL-FX52/L projector accepts a wide variety of input signals up to HDTV, as well as computer signals up to UXGA. What's more, it is also equipped with a DVI-D connector that can be used to connect a digital RGB device and supports high-precision signal connection with a workstation or other device.

DIRECT POWER ON

This selectable function enables the projector to be turned on and off via a wall switch or circuit breaker. This is especially useful for environments that do not have sophisticated control systems, such as auditoriums and conference halls in museums and schools.



	Short-focus Fixed Lens VPLL-ZM21	Short-focus Zoom Lens VPLL-ZM31	Long-focus Zoom Lens VPLL-ZM101
F	2.0	1.9-2.0	2.0-2.6
Throw ratio*	0.9:1	1.55-1.7:1	3.3-5.0:1
Zoom	—	x 1.1	x 1.5
Throwing Distance Screen size**		Wide	Tele
40-inch	690 mm	1190 mm	1250 mm
60-inch	1080 mm	1840 mm	1940 mm
80-inch	1460 mm	2490 mm	2620 mm
100-inch	1850 mm	3150 mm	3300 mm
120-inch	2240 mm	3800 mm	3980 mm
150-inch	2820 mm	4780 mm	5000 mm
200-inch	3780 mm	6410 mm	6710 mm
250-inch	4750 mm	8050 mm	8410 mm
300-inch	5720 mm	9680 mm	10120 mm
		Wide	Tele
2600 mm	3890 mm	2600 mm	3890 mm
4000 mm	5940 mm	4000 mm	5940 mm
5410 mm	7980 mm	5410 mm	7980 mm
6810 mm	10030 mm	6810 mm	10030 mm
8220 mm	12080 mm	8220 mm	12080 mm
10330 mm	15150 mm	10330 mm	15150 mm
13840 mm	20270 mm	13840 mm	20270 mm
17350 mm	25380 mm	17350 mm	25380 mm
20870 mm	30500 mm	20870 mm	30500 mm

* Distance between the centre of the projector lens and the screen, divided by the screen width.
** Viewable area, measured diagonally.

VARIETY OF OPTIONAL LENSES

The VPL-FX52 is supplied with a power lens as standard. The VPL-FX52L, which is not equipped with a lens, is ideal where a specific application requires a special lens. There are three alternative lens types available as options, enabling the VPL-FX52L to be installed in a wide range of applications – from long-distance projection in large auditoriums to short-distance rear projection applications.

NETWORK CAPABILITY

Because the VPL-FX52 is equipped with an Ethernet interface and complies with TCP/IP protocols, a number of network-based functions can be performed. Using a web browser, the projector's current status can, for example, be verified and simple settings can be checked and altered. The system can even be set up to send automatic e-mail reports for scheduled maintenance, including projected lamp life and error reports.

3 LCD Technology

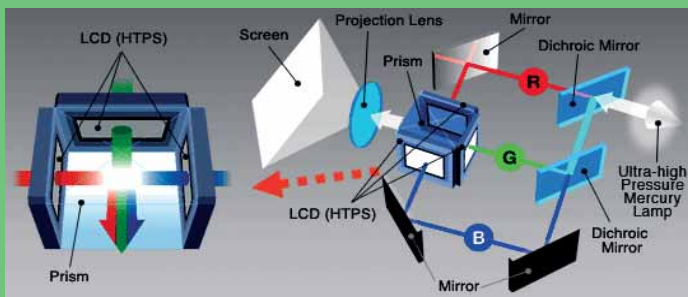

- The Sony VPL-FX52/L adopts a 3-LCD system using three 1.3-inch LCD Panels, also known as high-temperature polysilicon or HTPS.
- A 3-LCD projector divides white light emitted from the lamp into three basic colours of Red, Green and Blue and passes each colour through its own separate LCD (HTPS) panel producing rich, detailed quality to the final image.
- 3-LCD system light efficiency is excellent as each colour (Red, Green & Blue) is projected onto the screen at the same time. This provides a bright image and does not cause colour separation to the final image.
- Images produced on a 3-LCD system are bright, create a more natural colour and are gentle on the eyes.

Installation Diagrams

(When using the VPL-FX52 with supplied lens)

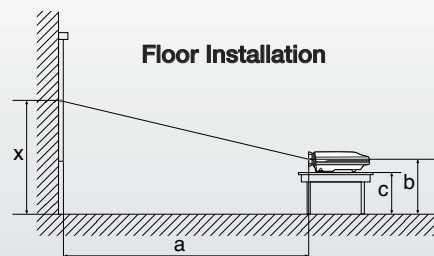

- a: Distance between the screen and the centre of the lens
- b: Distance from the floor to the centre of the lens
- c: Distance from the floor to the foot of the projector
- x: Free

Screen size*	40	60	80	100	120	150	200	250	300	
a	min	1490 (58 3/4)	2280 (89 7/8)	3060 (120 1/2)	3850 (151 5/8)	4630 (182 3/8)	5810 (228 7/8)	7770 (306)	9730 (383 1/8)	11690 (460 3/8)
	max	1820 (71 3/4)	2780 (109 1/2)	3740 (147 3/8)	4700 (185 1/8)	5660 (222 7/8)	7100 (279 5/8)	9500 (374 1/8)	11900 (468 5/8)	14300 (563 1/8)
b	min	x-305 (x-12 1/8)	x-457 (x-18)	x-610 (x-24 1/8)	x-762 (x-30)	x-914 (x-36)	x-1143 (x-45)	x-1524 (x-60)	x-1905 (x-75 1/8)	x-2286 (x-90 1/8)
	max	x								
c	min	x-417 (x-16 1/2)	x-569 (x-22 1/2)	x-722 (x-28 1/2)	x-874 (x-34 1/2)	x-1026 (x-40 1/2)	x-1255 (x-49 1/2)	x-1636 (x-64 1/2)	x-2017 (x-79 7/8)	x-2398 (x-94 1/2)
	max	x-102 (x-4 1/8)								

* Viewable area, measured diagonally.

SPECIFICATIONS

Optical	
Projection system	3 LCD panels, 1 lens projection system
LCD panel	1.3-inch TFT Sony LCD panel with Micro Lens Array, 2,359,296 (1024 x 768 x3) pixels
Projection lens	Approx. 1.3 times zoom lens f50.8 to 64.0 mm, F 1.7 to 2.0 (VPL-FX52L: lens is not supplied)
Lamp	300 W Lamp
Screen coverage	40 to 300 inches (viewable area measured diagonally)
Light output	6,000 ANSI lumens (lamp mode high), 5,100 ANSI lumens lamp mode standard)

Signals	
Colour system	NTSC 3.58, PAL, SECAM, NTSC 4.43, PAL-M, PAL-N (automatically/manually selected)
Resolution	Video : 750 TV lines, RGB : 1024 x 768 pixels
Acceptable computer signal	fH : 19 to 92 KHz, fV : 48 to 92 Hz (Up to UXGA 60 Hz)
Acceptable video signal	15k RGB 50/60 Hz, Progressive Component 50/60 Hz, DTV (480/60i, 575/50i, 480/60p, 575/50p, 1080/50i, 720/60p, 720/50p, 540/60p), Composite Video, Y/C Video

General	
Dimension (WxHxD)	VPL-FX52: 420 x 169 x 502 mm (19 x 6 5/8 x 19 7/8 inches) VPL-FX52L: 420 x 169 x 464 mm (19 x 6 5/8 x 18 3/8 inches)
Mass	VPL-FX52: Approx. 10.5 kg (23 lbs 4 oz) VPL-FX52L: Approx. 9.1 kg (20 lbs 1 oz)
Power requirements	AC 100 to 240 V, 50/60 Hz
Power consumption	Max. 400 W, Standby 7 W
Heat dissipation	1365 BTU
Operating temperature	0 to 35 °C (32 to 95 °F)
Operating humidity	35 to 85% (no condensation)
Storage temperature	-20 to 60 °C (-4 to 140 °F)
Storage humidity	10 to 90%

Inputs/Outputs		
Video IN	Video	BNC
	S Video	Y/C Mini DIN 4-pin
Video OUT	Video	Loop-through BNC type
	S Video	Loop-through mini DIN 4-pin (male)
Input A	RGB	Analogue RGB : HD D-sub 15-pin (female)
Input B	RGB	Digital RGB : DVI-D (TMDS)
Input C	RGB	Analogue RGB/component : 5 BNC (female)
Monitor out		HD D-sub 15-pin (female)
TRIG		Mini jack
RS-232C		D-sub 9 pin (female)
CONTROL S IN		Stereo mini jack, 5 Vp-p, plug-in-power
Network		RJ-45 : 10Base-T/100Base-TX

Supplied Accessories
Remote Commander Unit, Size AA (R6) Batteries (x2), Lens Cap (VPL-FX52 only), AC Power Cord, Air Filter, Operating Instructions and Installation Manual for Dealers (CD-ROM), Quick Reference Manual, Safety Regulations, Security Label, Warranty Card

Optional Accessories
LMP-F300 Projector Lamp, PSS-620 Suspension Support, RM-PJK1 Presentation Tool

PRESET SIGNAL CHART**

No.	Resolution	fH (kHz)	fV (Hz)	Sync (H/V)	
1	Video 60 Hz	15.734	59.940	N/N	
2	Video 50 Hz	15.625	50.000	N/N	
3	15k RGB/Component 60 Hz	15.734	59.940	S on G/Y or Composite sync	
4	15k RGB/Component 50 Hz	15.625	50.000		
5	HDTV	33.750	60.000		
6*	640 x 350	VGA mode 1	31.469	70.086	P/N
7*		VGA VESA 85 Hz	37.861	85.080	P/N
8*	640 x 400	PC-9801 Normal	24.823	56.416	N/N
9*		VGA mode 2	31.469	70.086	N/P
10*		VGA VESA 85 Hz	37.861	85.080	N/P
11*	640 x 480	VGA mode 3	31.469	59.940	N/N
12*		Macintosh 13"	35.000	66.667	N/N
13*		VGA VESA 72 Hz	37.861	72.809	N/N
14*		VGA VESA 75 Hz	37.500	75.000	N/N
15*		VGA VESA 85 Hz	43.269	85.008	N/N
16*	800 x 600	SVGA VESA 56 Hz	35.156	56.250	P/P
17*		SVGA VESA 60 Hz	37.879	60.317	P/P
18*		SVGA VESA 72 Hz	48.077	72.188	P/P
19*		SVGA VESA 75 Hz	46.875	75.000	P/P
20*		SVGA VESA 85 Hz	53.674	85.061	P/P
21*	832 x 624	Macintosh 16"	49.724	74.550	N/N
22*	1,024 x 768	XGA VESA 43 Hz	35.524	86.958	P/P
23*		XGA VESA 60 Hz	48.363	60.004	N/N
24*		XGA VESA 70 Hz	56.476	69.955	N/N
25*		XGA VESA 75 Hz	60.023	75.029	P/P
26*		XGA VESA 85 Hz	68.677	84.997	P/P
27*	1,152 x 864	SXGA VESA 70 Hz	63.995	70.019	P/P
28		SXGA VESA 75 Hz	67.500	75.000	P/P
29		SXGA VESA 85 Hz	77.487	85.057	P/P
30*	1,152 x 900	Sunmicro LO	61.795	65.960	N/N
31		Sunmicro HI	71.713	76.047	Composite sync
32*	1,280 x 960	SXGA VESA 60 Hz	60.000	60.000	P/P
33		SXGA VESA 75 Hz	75.000	75.000	P/P
34*	1,280 x 1,024	SXGA VESA 43 Hz	46.433	86.872	P/P
35		SGI-5	53.316	50.062	S on G
36*		SXGA VESA 60 Hz	63.974	60.013	P/P
37		SXGA VESA 75 Hz	79.976	75.025	P/P
38		SXGA VESA 85 Hz	91.146	85.024	P/P
39	1,600 x 1,200	UXGA VESA 60 Hz	75.000	60.000	-
43	480/60P	480/60P (Double Frequency NTSC)	31.470	60.000	S on G
44	575/50P	575/50P (Double Frequency PAL)	31.250	50.000	S on G
45	1,080/50i	1,080/50i	28.130	50.000	-
47	720/60P	720/60P	45.000	60.000	-
48	720/50P	720/50P	37.500	50.000	-
50	540/60P	540/60P	33.750	60.000	-
52	1,400 x 1,050	SXGA+	63.981	60.020	N/N

* Digital input is supported for the signals marked with an asterisk.

** If you would like to input a signal that is not listed in the above chart, please contact your local Sony sales office.



Lead-free solder is used for soldering all parts including circuit component electrodes. Halogenated flame retardants are not used in cabinets.

Installation Diagrams

(When using the VPL-FX52 with supplied lens)

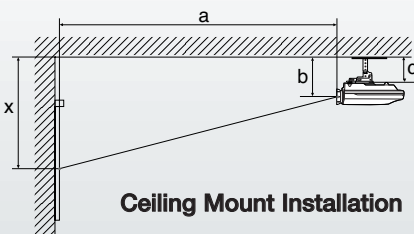

Ceiling Mount Installation

- a: Distance between the screen and the centre of the lens
- b: Distance from the ceiling to the centre of the lens
- c: Distance from the ceiling to the mounting surface of the suspension bracket (183/208/233/283/308/335 mm adjustable when using the PSS-620)
- x: Distance from the ceiling to the centre of the screen

Screen size*	40	60	80	100	120	150	200	250	300	
a	min	mm 1490 (58 3/4)	mm 2280 (89 7/8)	mm 3060 (120 1/2)	mm 3850 (151 5/8)	mm 4630 (182 3/8)	mm 5810 (228 7/8)	mm 7770 (306)	mm 9730 (383 1/8)	mm 11690 (460 3/8)
	max	mm 1820 (71 3/4)	mm 2780 (109 1/2)	mm 3740 (147 3/8)	mm 4700 (185 1/8)	mm 5660 (222 7/8)	mm 7100 (279 5/8)	mm 9500 (374 1/8)	mm 11900 (468 5/8)	mm 14300 (563 1/8)
b	min	mm c+91.4 (c+3 5/8)								
	max	mm c+101.4 (c+4)								
x	min	mm c+100 (c+4)								
	max	mm c+406 (c+16)	mm c+558 (c+22)	mm c+711 (c+28)	mm c+863 (c+34)	mm c+1015 (c+40)	mm c+1244 (c+49)	mm c+1625 (c+64)	mm c+2006 (c+79)	mm c+2387 (c+94)

* Viewable area, measured diagonally.

Dimensions

Unit: mm (inches)

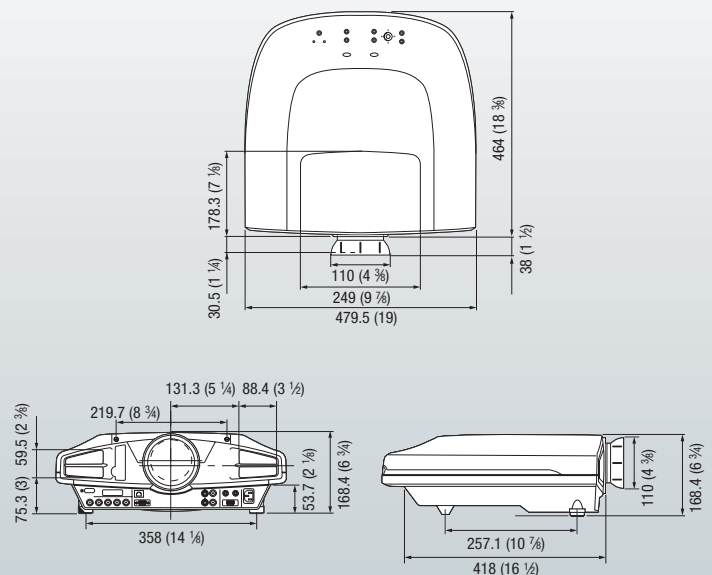

Main features at a glance

Outstanding brightness of 6000 ANSI Lumens

Delivers high-impact images with stunning colour fidelity

3LCD Projection System

For brighter, more natural images

Unique and Stylish Sony Design

The projector blends in with its environment

Sony DDE (Dynamic Detail Enhancer)

Generates high-quality video images of outstanding quality

RGB Enhancer

For enriched and crisp RGB reproduction

3D Gamma Correction

Ensures uniform colour and brightness right to the corners of the screen

3D Digital Comb Filter

Emphasises fine images and shape boundaries

Digital Keystone Adjustment

Means undistorted projection, wherever installed

Multi-Function Remote Commander

Useful for projector set-up and delivering presentations

4 x Digital Zoom and Freeze

Helps get your message across more clearly

Smart APA (Auto Pixel Alignment)

Automatically adjusts image displays for optimum picture

Password Protection

Restricts unauthorised use of the projector

Multi-Language On-Screen Display

Choice of 9 languages

INTERLACE / PROGRESSIVE CONVERSION

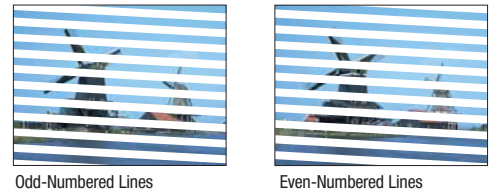

Odd-Numbered Lines

Even-Numbered Lines



(simulated image)

2-3 PULL DOWN

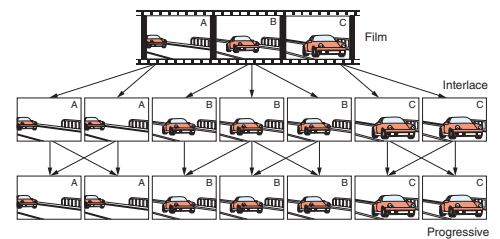

DIGITAL KEYSTONE ADJUSTMENT



(simulated image)

Service & Support

A PrimeSupport 3-year service offering is included with the VPL-FX52/L. Providing more than the standard warranty, PrimeSupport brings you the following valuable benefits:

- Multi-lingual helpdesk, where the fully-trained team will guide you through the many features of the product and also co-ordinate any service request that you may have during the contract life.
- Qualified Sony engineers will carry out any necessary repairs, giving you peace of mind that there will be no unexpected repair bills whilst your VPL-FX52/L is covered by PrimeSupport.



SONY®

www.sonybiz.net/projectors

© 2005 Sony Corporation. All rights reserved. Reproduction in whole or in part without written permission is prohibited. Features and specifications are subject to change without notice. All non-metric weights and measurements are approximate. Projected images in this brochure are simulated. Sony is a registered trademark of Sony Corporation. Remote Commander is a trademark of Sony Corporation. All other trademarks are the property of their respective owners.
CA VPL-FX52/L/GB-05/12/2005